





R2M

miniature industrial relays



- Relays of general application
- For plug-in sockets: on 35 mm rail mount acc. to EN 60715; on panel mounting
- For PCB and for soldering connections
- AC and DC coils, insulation class F: 155 °C
- Recognitions, certifications, directives: RoHS,   

Contact data

Number and type of contacts		2 CO
Contact material		AgNi  , AgNi/Au flash gold plating, AgSnO ₂
Rated / max. switching voltage	AC	250 V / 250 V
Min. switching voltage		5 V AgNi, 5 V AgNi/Au flash gold plating, 10 V AgSnO ₂
Rated load	AC1	5 A / 250 V AC
	DC1	5 A / 24 V DC
Min. switching current		5 mA AgNi, 5 mA AgNi/Au flash gold plating, 10 mA AgSnO ₂
Rated current		5 A
Max. breaking capacity	AC1	1 250 VA
Min. breaking capacity		0,3 W AgNi, 0,3 W AgNi/Au flash gold plating, 1 W AgSnO ₂
Contact resistance		≤ 100 mΩ
Max. operating frequency		
• at rated load	AC1	1 200 cycles/hour
• no load		36 000 cycles/hour

Coil data

Rated voltage	50/60 Hz AC	6, 12, 24 , 50, 100, 110, 115, 120, 220, 230 , 240 V
	DC	6, 12 , 24 , 48, 60, 80, 110 V
Must release voltage		≥ 0,05 U _n
Operating range of supply voltage		see Tables 1, 2
Rated power consumption	AC	1,2 VA
	DC	0,9 W

Insulation according to EN 60664-1

Insulation rated voltage		250 V AC
Rated surge voltage		2 500 V 1,2 / 50 μs
Overvoltage category		II
Insulation pollution degree		3
Dielectric strength		
• between coil and contacts		2 000 V AC type of insulation: basic
• contact clearance		1 000 V AC type of clearance: micro-disconnection
• pole - pole		2 000 V AC type of insulation: basic
Contact - coil distance		
• clearance		≥ 3 mm
• creepage		≥ 4 mm

General data

Operating / release time (typical values)		AC: 8 ms / 7 ms	DC: 10 ms / 3 ms
Electrical life			
• resistive AC1		> 2 x 10 ⁵	5 A, 250 V AC
• cosφ		see Fig. 2	
Mechanical life (cycles)		> 10 ⁷	
Dimensions (L x W x H)		27,5 x 14 x 32,9 mm	
Weight		22 g	
Ambient temperature	• storage	-40...+70 °C	
(non-condensation and/or icing)	• operating	-40...+55 °C	
Cover protection category		IP 40	EN 60529
Shock resistance		10 g	
Vibration resistance		5 g 10...150 Hz	
Solder bath temperature		max. 270 °C	
Soldering time		max. 5 s	

The data in bold type relate to the standard versions of the relays.  Relays with AgNi contacts can be used up to 5 A at resistive and inductive load.

Dimensions - plug-in version

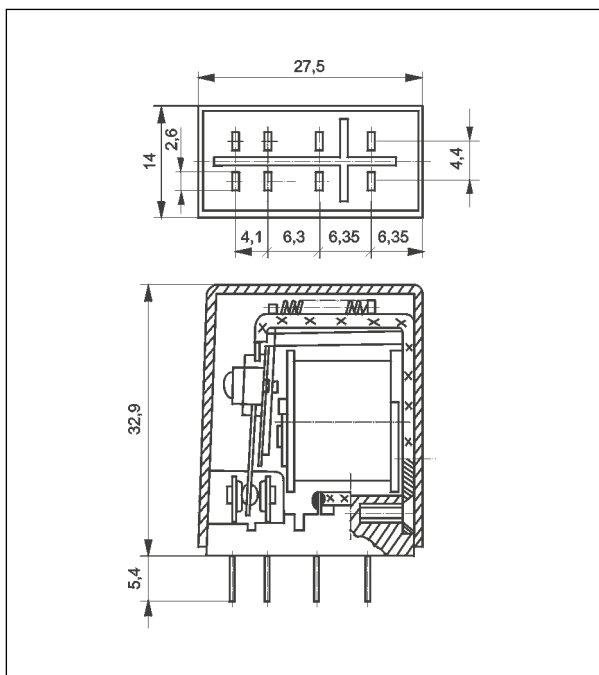

Dimensions - PCB version

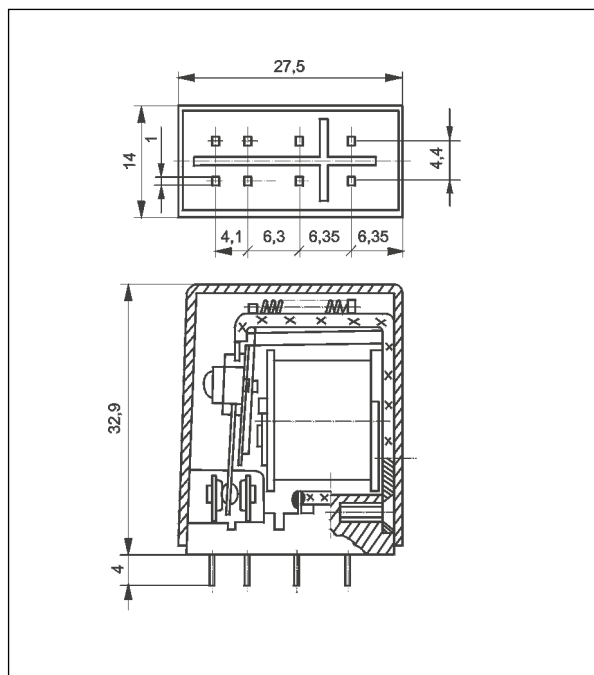

Mounting, sockets and accessories for relays

Relays **R2M** are designed for: • plug-in sockets • direct PCB mounting.

Sockets for R2M	Accessories	Additional features
	Spring wire clips	
Screw terminals sockets, 35 mm rail mount (EN 60715) or on panel mounting (two M3 screws)		
GZ2	GZ2 1060 ②	—
Sockets for PCB		
S2M	G4 1050	—
Solder terminals sockets		
G2M	G4 1050	spring clamps ③

② Set GZ2 1060: spring wire clip and two spring clamps.

③ Spring clamps G2M 1020 for spring wire clips.

GZ2

Screw terminals
plug-in sockets
for R2M
- see page 5

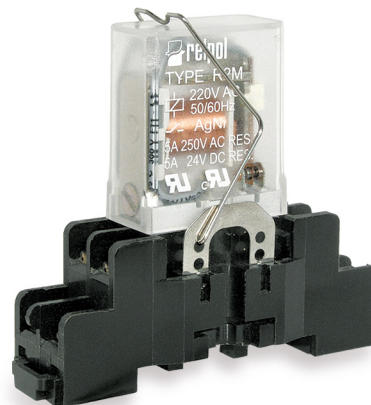

Connection diagram (pin side view)

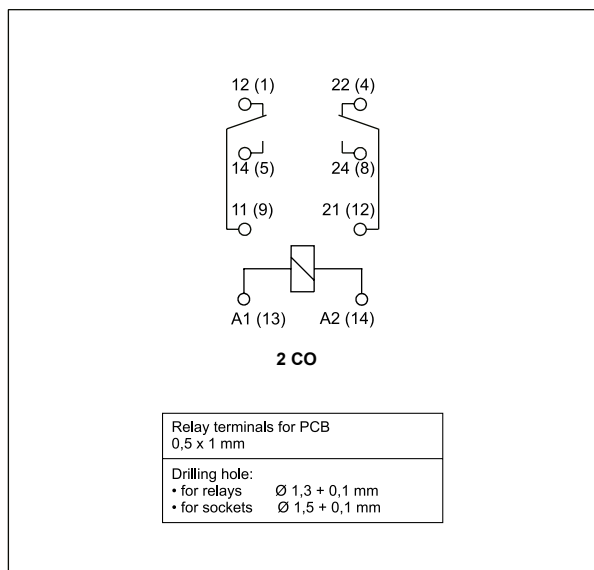

Electrical life at AC resistive load. Switching frequency: 1 200 cycles/hour

Fig. 1

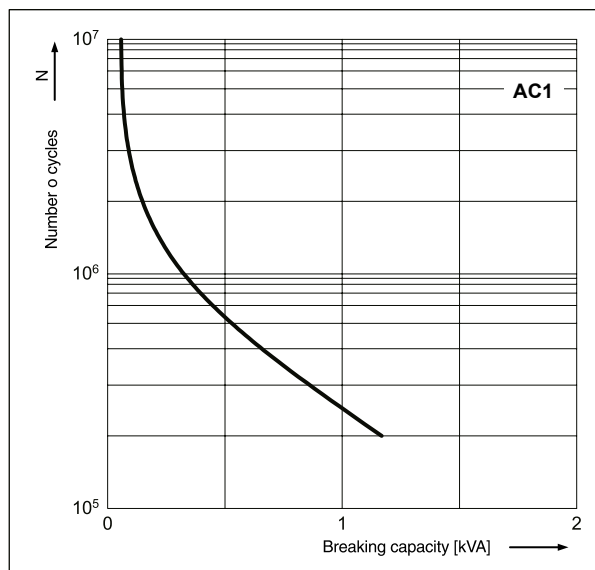

Electrical life reduction factor at AC inductive load

Fig. 2

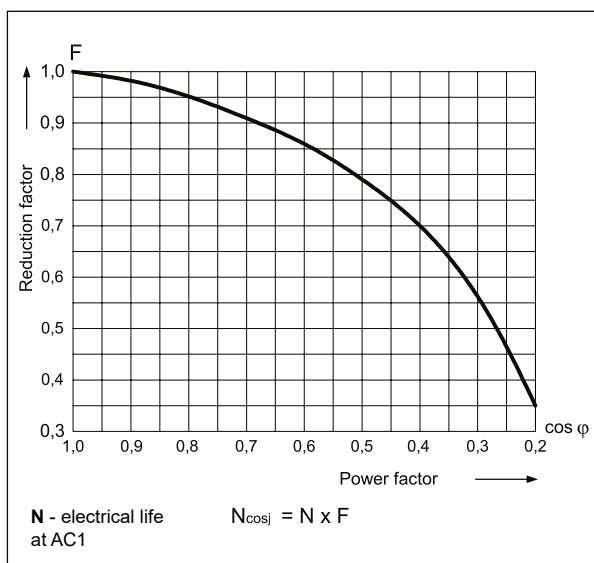

Max. DC resistive load breaking capacity

Fig. 3

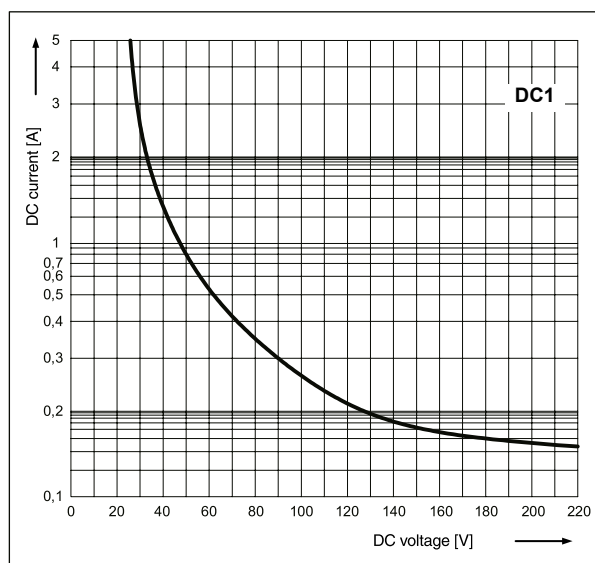

Contact material selection for different load types

- **AgNi** - for resistive or inductive loads,
- **AgNi/Au flash gold plating** - Au protects the contact surface during storage,
- **AgSnO₂** - for capacitive loads or incandescent lamp loads.

Coil data - DC voltage version

Table 1

Coil code	Rated voltage V DC	Coil resistance at 20 °C Ω	Acceptable resistance	Coil operating range V DC	
				min. (at 20 °C)	max. (at 55 °C)
1006	6	47	± 10%	4,8	6,6
1012	12	188	± 10%	9,6	13,2
1024	24	750	± 10%	19,2	26,4
1048	48	2 660	± 10%	38,4	52,8
1060	60	4 000	± 10%	48,0	66,0
1080	80	7 100	± 10%	64,0	88,0
1110	110	13 480	± 10%	88,0	121,0

The data in bold type relate to the standard versions of the relays.

Coil data - AC 50/60 Hz voltage version

Table 2

Coil code	Rated voltage V AC	Coil resistance at 20 °C Ω	Acceptable resistance	Coil operating range V AC	
				min. (at 20 °C)	max. (at 55 °C)
5006	6	16	± 10%	4,8	6,6
5012	12	68	± 10%	9,6	13,2
5024	24	270	± 10%	19,2	26,4
5050	50	1 150	± 10%	40,0	55,0
5100	100	5 590	± 10%	80,0	110,0
5110	110	5 670	± 10%	88,0	121,0
5115	115	5 990	± 10%	92,0	126,0
5120	120	6 390	± 10%	96,0	132,0
5220	220	21 470	± 10%	176,0	242,0
5230	230	21 470	± 10%	184,0	253,0
5240	240	25 390	± 10%	192,0	264,0

The data in bold type relate to the standard versions of the relays.

Ordering codes

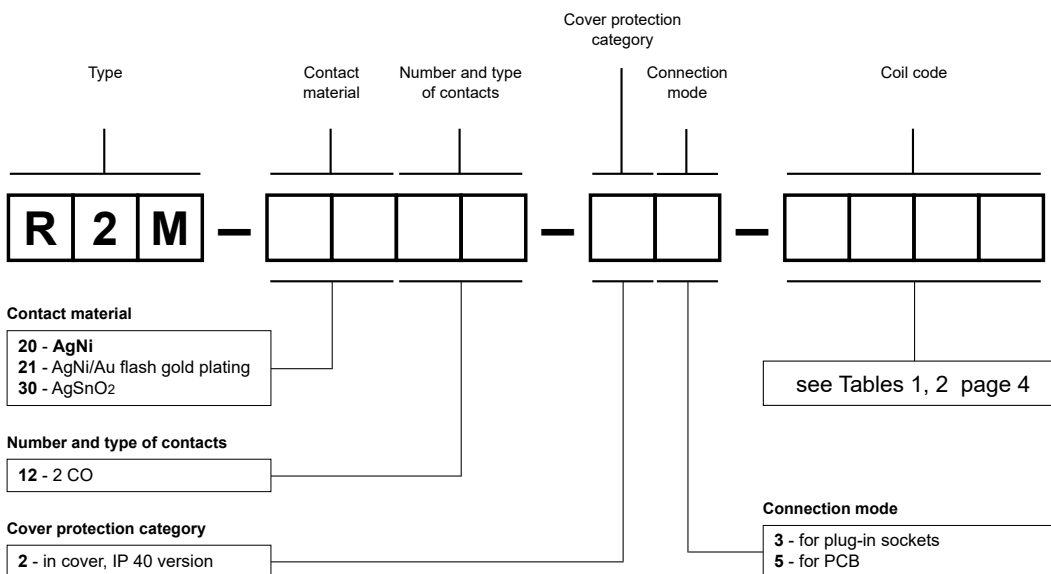

Examples of ordering codes:

- R2M-2012-23-5230** relay **R2M**, for plug-in sockets, two changeover contacts, contact material AgNi, coil voltage 230 V AC 50/60 Hz, in cover IP 40
- R2M-2012-25-1024** relay **R2M**, for PCB, two changeover contacts, contact material AgNi, coil voltage 24 V DC, in cover IP 40

Plug-in sockets and accessories

GZ2

For R2M

Screw terminals
 Max. tightening moment
 for the terminal: 0,7 Nm
 35 mm rail mount
 acc. to EN 60715
 or on panel mounting
 65,2 x 20 x 25 mm
 Two poles
 7 A, 250 V AC

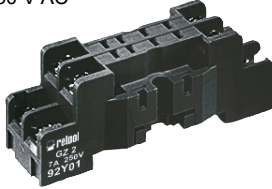

Connection diagram

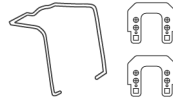
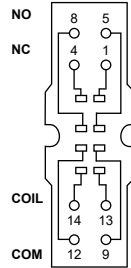

GZ2 1060

Dimensions

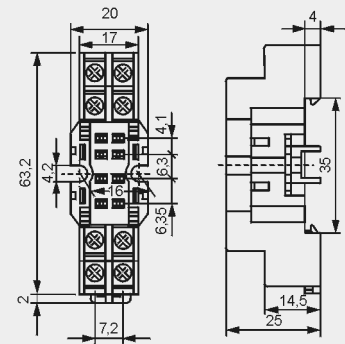

S2M

For R2M

For PCB
 29,6 x 14 x 10,5 mm
 Two poles
 5 A, 250 V AC

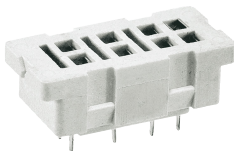

Pinout

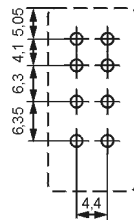

G4 1050

Dimensions

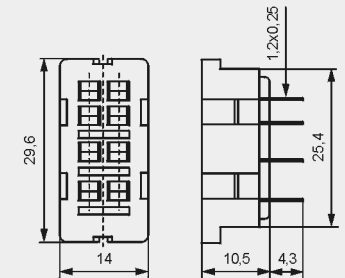

G2M

For R2M

Solder terminals
 40,5 x 14 x 10,5 mm
 Two poles
 5 A, 250 V AC

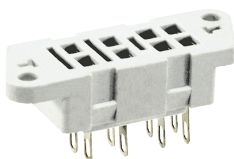

Accessories



G4 1050



G2M 1020

Dimensions

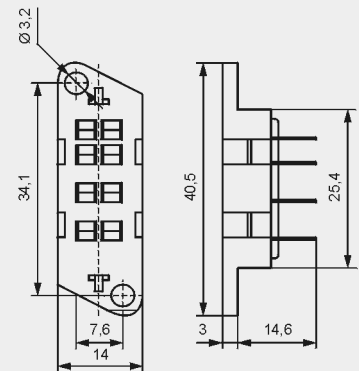

PRECAUTIONS:

1. Ensure that the parameters of the product described in its specification provide a safety margin for the appropriate operation of the device or system and never use the product in circumstances which exceed the parameters of the product. 2. Never touch any live parts of the device. 3. Ensure that the product has been connected correctly. An incorrect connection may cause malfunction, excessive heating or risk of fire. 4. In case of any risk of any serious material loss or death or injuries of humans or animals, the devices or systems shall be designed so to equip them with double safety system to guarantee their reliable operation.